

BEETLE /iPOS plus Advanced

All-in-one POS System

We would like to know your opinion on this publication.

Please send us a copy of this page if you have any constructive criticism.
We would like to thank you in advance for your comments.

With kind regards,

Your opinion:

Wincor Nixdorf International GmbH
Technical Documentation R&D SAT22
Wohlrabadamm 31
D-13629 Berlin
E-Mail: retail.documentation@wincor-nixdorf.com

Order No.: **01750259126C**

BEETLE /iPOS plus Advanced

All-in-one POS System

User Manual

Edition June 2014

All brand and product names mentioned in this document are trademarks of their respective owners.

Copyright © Wincor Nixdorf International GmbH, 2013

The reproduction, transmission or use of this document or its contents is not permitted without express authority.

Offenders will be liable for damages.

All rights, including rights created by patent grant or registration of a utility model or design, are reserved.

Delivery subject to availability; technical modifications possible.

Contents

Manufacturer’s Certification	1
FCC-Class A Declaration	1
BSMI (EMC for Taiwan)	1
Energy Efficiency	2
Important Notes	3
Safety Notes	4
Introduction	6
About This Manual	6
Care of the BEETLE /iPOS plus Advanced	7
Recycling the BEETLE /iPOS plus Advanced.....	7
Warranty	8
Unpacking And Checking the Delivery Unit.....	8
Basic settings	9
Components.....	9
Processors Type.....	9
RAM.....	9
Hard Disk Options.....	9
Display	9
Replacing the Lithium Battery.....	10
Setting Up the Device	12
Ergonomic Terminal Workplace	12
Overview	14
Front View with Stand	14
Back View with Stand.....	15
AC Power Adapter	16
Front Panel.....	17
Projective Capacitive Touch Screen	18
General Information	18
Instructions for Using the Touch Screen	18
Cleaning Instructions	19
Resistive Touch Screen	20

General Information	20
Construction of the Resistive Touch Screen	20
Instructions for Using the Touch Screen	21
Cleaning Instructions	21
Planning the installation	22
Dimensions.....	22
Desktop version.....	22
Wall mount version.....	23
Required operation space	23
Installation site requirements	24
Desktop version.....	24
Wall mount version	24
Installing to a stand	25
Preparing the stand	25
Preparing the display	25
Installing the stand	27
Connector panel.....	30
Connecting cables.....	31
Disconnecting cables.....	32
Storage Media.....	34
Replacement of the Hard Disk Drive	34
Second Hard Disk Drive	37
Installing the second hard disk drive	37
Replacement of the RAM	41
Installing to a wall	43
Things you need.....	43
Preparation.....	45
Connecting the display	45
Mounting height.....	46
Mounting location	46
Installation.....	47
Fix wall mount back plate to the wall	47
Fix wall mount front plate to the system	48
Secure the system to the wall	48
Peripherals	50
Magnetic Swipe Card Reader (Option).....	50
How To Operate	50

Cleaning Instructions	51
Waiter Lock (Option)	51
Installing peripherals	52
Starting Up the System	55
Error reporting	57
Technical Data.....	58
AC Power Adapter	59
Projected Capacitive Touch Screen	59
Resistive Touch Screen	59
MSR Module.....	60
Waiter Lock (iButton) Module.....	60
iPOS plus I/O Hub	61
Appendix.....	62
Approved Printers List	62
Abbreviations.....	63

Manufacturer's Certification



The device complies with the requirements of the EEC directive 2004/108/EC with regard to "Electromagnetic compatibility" and 2006/95/EC "Low Voltage Directive" and RoHS directive 2011/65/EU.

Therefore, you will find the CE mark on the device or packaging.



In addition, the BEETLE /iPOS plus Advanced has received the UL symbol and cUL symbol.

FCC-Class A Declaration

This equipment has been tested and found to comply with the limits for a Class A digital device, pursuant to part 15 of the FCC Rules. These limits are designed to provide reasonable protection against harmful interference when the equipment is operated in a commercial environment. This equipment generates, uses, and can radiate radio frequency energy and, if not installed and used in accordance with the instruction manual, may cause harmful interference to radio communications. Operation of this equipment in a residential area is likely to cause harmful interference in which case the user will be required to correct the interference at his own expense. Modifications not authorized by the manufacturer may void users authority to operate this device.

This class A digital apparatus complies with Canadian ICES-003.

Cet appareil numerique de la classe A est conforme à la norme NMB-003 du Canada.

BSMI (EMC for Taiwan)



The device complies with the requirements of the BSMI (Bureau of Standards, Metrology and Inspection, Ministry of Economic Affairs) directive CNS13438 with regard to "Electromagnetic compatibility" with the limits for a Class B product.

Energy Efficiency

iPOS plus Advanced is tested in an accredited test lab and can meet the Eligibility Criteria for Integrated Desktop laid down in ENERGY STAR version 6.0 for Computers. On a request basis, an application can be made to Energy Star for listing.

Important Notes

The Wincor Nixdorf International GmbH is not responsible for any radio and television malfunctions which emerge from unauthorized changes in the device. Make sure that only cables and devices may be connected which are admitted by Wincor Nixdorf. The user is responsible for any malfunctions that emerge from the actions mentioned before.



The device may only be repaired by authorized qualified personnel. Unauthorized opening of the device and inexpertly carried-out repairs may not only seriously jeopardize the safety of the user, but also cancel all warranty and liability agreements.



Expansion cards with electrostatically sensitive devices (ESD) *may* be marked with this sticker.

When opening the device or handling modules fitted with ESD, please observe the following instructions, which pertain to all electrostatic sensitive devices (ESDs):

- Always use the antistatic kit.
- Statically discharge yourself, for example by touching an earthed object (such as a heat radiator) before beginning to work with ESD-labeled components.
- Likewise, all equipment and tools used in working with such components must be free of static charge.
- Pull the mains plug before inserting or removing such components.
- Only handle such components by their edges.
- Never touch any terminal pins of the strip conductors on such components.

Safety Notes

The BEETLE /iPOS plus Advanced conforms to the current safety standards for data processing equipment.

- If this device is taken from a cold environment into the operating room, moisture condensation may form. The device must be absolutely dry before being put into service; an acclimatization period of at least two hours must therefore be observed.
- This device is equipped with a safety-tested power cable and may be connected only to a prescribed grounded-contact power socket.
- When setting up the device, ensure that the power socket on the device and the grounded-contact power socket are easily accessible.
- Whenever work of any kind is done on the device, as well as when data cables are plugged and/or unplugged, the device must be completely disconnected from the line voltage. To do so, turn the device off and unplug the power cord.
- To disconnect the device from the supply voltage completely, switch off the device and disconnect the power plug of the system.
- Never plug in or unplug data communication lines during thunderstorms.
- Protect devices from vibrations, dust, moisture and heat.
- Always dispose of used parts, such as batteries, in an environmentally safe manner.
- In emergencies (e.g. damaged housing or damaged power cable, penetration by liquids or foreign bodies), the device must be switched off immediately, the power plug disconnected and the Customer Service of Wincor Nixdorf or your dealer must be notified.
- Your BEETLE system is the result of modern technical innovation. So please see for according structural and technical surroundings to guarantee a faultless and efficient work of your BEETLE. Therefore, you should connect your BEETLE or other IT-devices only to power supply systems with separately guided protective earth conductor (PE). This kind of electricity system is known as TN-S network. Do not use PEN conductors!

Please also observe the recommendations of the norm DIN VDE 0100, Part 540, Appendix C2 as well as EN50174-2, §5.4.3. Thus you can help to avoid possible mal functions.

- If you replace a storage medium, make sure that you only use the storage medium recommended or approved by Wincor Nixdorf.
- You can connect or disconnect USB devices during operation of your BEETLE, provided that these devices comply with the specifications according to *usb.org*. Other peripheral devices (such as PoweredUSB printer) should be connected to or disconnected from your BEETLE system only after the BEETLE has been switched off.

Introduction

The BEETLE /iPOS plus Advanced 15" comes in two variants, one with the Projected Capacitive and the other with Resistive touch.

Its key features are the bezel-free design with multi-touch capabilities and the elegantly designed aluminum back housing coupled with its support for the high performance i3 and i5 processors as well as the value range of Celeron/Pentium processors.

About This Manual

This documentation is intended to help you to work with the POS system and to serve as a reference work. The detailed table of contents help you find the desired information quickly and easily.



Notes in the manual are marked by this symbol.



This symbol is used for warnings.

The type and scope of application programs depend on the customer's own selection; therefore, software will not be discussed further in this manual.

Care of the BEETLE /iPOS plus Advanced

Clean your system's housing at regular intervals with a dry, lint-free cloth. If this does not suffice please use a suitable plastic-surface cleaner which you can order from Wincor Nixdorf International GmbH.

For more information about cleaning read the chapter "Projective Capacitive Touch Screen" and "Resistive Touch Screen". When cleaning always make sure that the power plug is disconnected and that no liquid finds its way into the device.

Recycling the BEETLE /iPOS plus Advanced

Environmental protection does not begin when the time has come to dispose of the BEETLE; it begins with the manufacturer. This product was designed according to our internal norm "Environmental conscious product design and development".

The BEETLE /iPOS plus Advanced system is manufactured without the use of CFC and CHC and is produced mainly from reusable components and materials.

Please do not stick labels onto plastic case parts. This would help us to reuse components and material.

But there are still some parts that are not reusable. Wincor Nixdorf International GmbH guarantees the environmentally safe disposal of these parts in a Recycling Center, which is certified pursuant to ISO 9001 and ISO 14001.

You can protect our environment by only switching on your equipment when it is actually needed. If possible, even avoid the stand-by-mode as this wastes energy, too. Also switch your equipment off when you take a longer break or finish your work.

Please contact your competent branch or the Recycling Center Paderborn (for European countries) for information on how to return and reuse devices and disposable materials under the following mail address.

Email: info@wincor-nixdorf.com or on the internet.

Warranty

In general, damages due to

- improper or insufficient maintenance,
- improper use of the product or unauthorized modifications of the product,
- inadequate location or surroundings

will not be covered by the warranty.

For further information on the stipulation consult your contract.

All parts of the product which are subject to wear and tear are not included in the warranty engagement. For detailed warranty arrangements please consult your contract documents.

Please order *spare parts* at the Wincor Nixdorf customer service.

Unpacking And Checking the Delivery Unit

Unpack the parts and check to see whether the delivery matches the information on the delivery note. The delivery comprises the respective screen module. Data cables, necessary for operation, can be ordered separately. If damage has occurred during shipping or if the package contents do not match the delivery note, immediately inform your Wincor Nixdorf sales outlet.

Transport the device only in its original packaging (to protect it against impact and shock).

Basic settings

The BEETLE /iPOS plus Advanced is configured to your order. Additional peripheral devices are delivered separately, for example the swipe card reader. The modules must still be mounted to the system.

Components

The BEETLE /iPOS plus configuration can consist of the following components:

Processors Type

Celeron G1820TE
Intel Pentium G3320TE
Intel Core i3-4330TE
Intel Core i5-4570TE

RAM

2 x DDR3 SODIMM socket
DDR3 SODIMM up to 1600MHz
Maximum size is 16GB

Hard Disk Options

1x 2.5" format-factor docking drive bay for 7mm thick hard disk or SSD

Display

15" Color TFT LED backlight with touch options:

- projected Capacitive touch, 2-touch multi-touch, or
- 5-wire Resistive Touch screen

Replacing the Lithium Battery



Incorrect replacement of the Lithium Battery may lead to a risk of explosion.

The end user must replace the lithium battery only by identical batteries or types recommended by Wincor Nixdorf.

Do not throw Lithium Batteries into the trashcan. It must be disposed of in accordance with local regulations concerning special waste.

Make sure that you insert the Battery the right way round by the indicated polarity in the picture below.

Follow the following steps to replace the Lithium battery.



Always make sure that the system is switched off before you replace the battery.

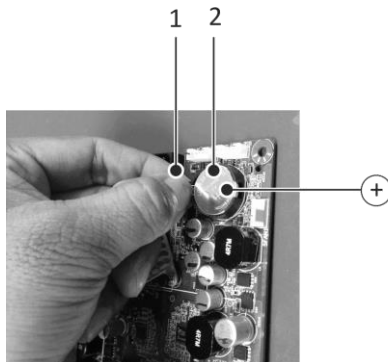

Push the spring latch (1) and remove the Lithium Battery from its Socket (2).

Insert and press a new Lithium Battery of same type in the Socket.

Make sure that you insert the battery the right way round, by the indicated polarity in the picture above.

Setting Up the Device

The BEETLE /iPOS plus Advanced was developed for an in-house installation. The device is designed to be mounted on a stand (desktop version) or on the wall (wall mount version).

Set up the BEETLE /iPOS plus Advanced system where it will not be exposed to extreme environmental conditions. Protect the device from vibrations, dust, moisture, heat and strong magnetic fields.

Ergonomic Terminal Workplace

Please observe the following when setting up your terminal workplace:

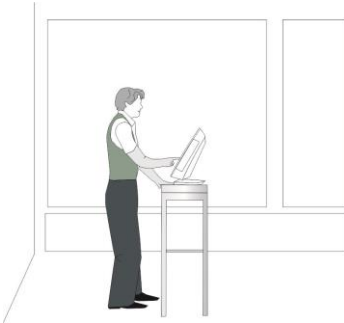

Avoid direct glaring and reflective glaring. Use the screen only in a controlled luminance surrounding. Install the device with a viewing direction that is parallel to the windows.

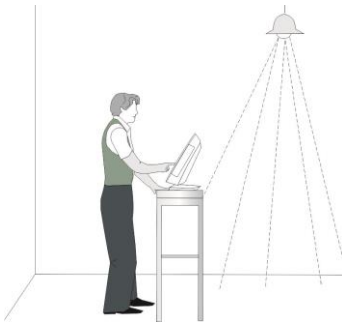

Avoid reflective glaring caused by electric light sources.

Permitted range of vision



Position the screen within a preferred and permitted range of vision, so that you can look onto the screen from above.

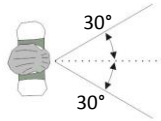

Preferred range of vision

Overview

Front View with Stand



1	Display
2	Stand
3	Brightness adjustment, LEDs
4	Power status indicator

Back View with Stand

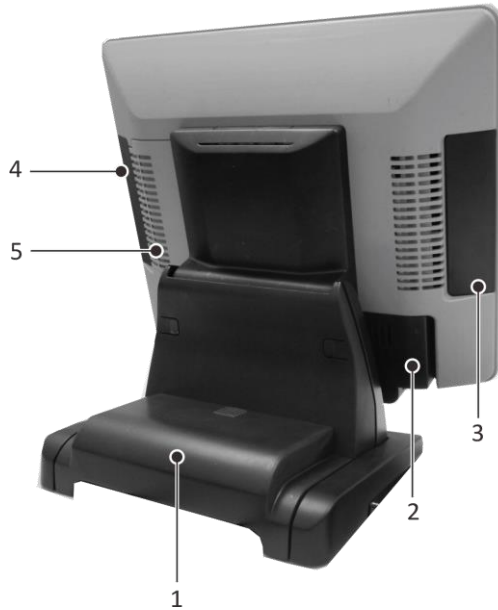

1	Base cover
2	Cable connection cover
3	Side-attach peripheral connection cover
4	Side-attach peripheral connection cover
5	RAM/mini-PCle cover

AC Power Adapter

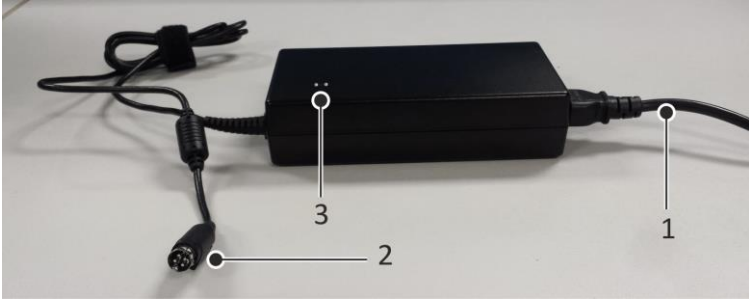

1	Power Connector
2	DC Power Out
3	Power LED

The external power supply is applicable for common line voltage. It automatically adjusts itself to the particular voltage (for grid input voltage and power supply see appendix).

Front Panel

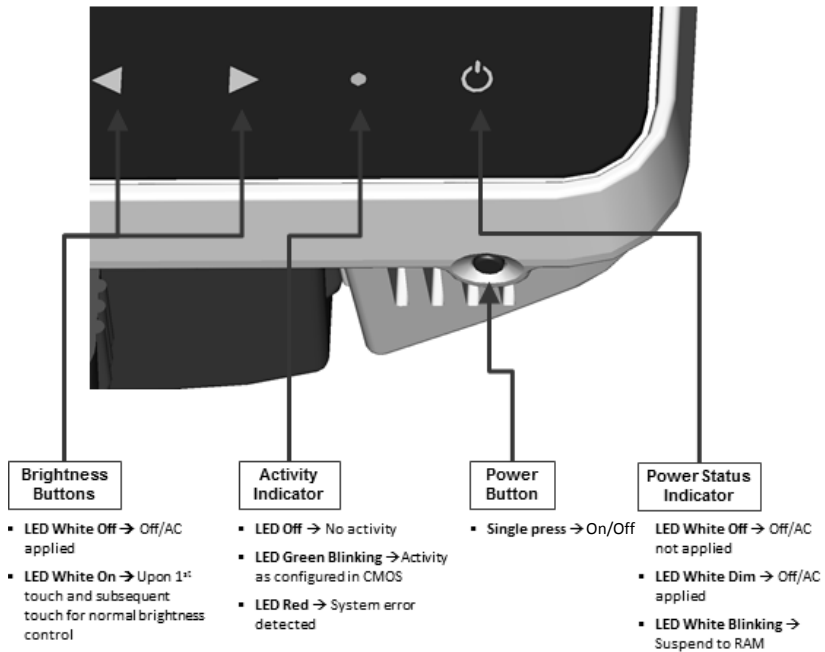

Projective Capacitive Touch Screen

General Information

The use of projective-capacitive touch screens has all the benefits a normal capacitive touch screen has:

- fast processing of touch information
- high sensitivity (use with hands, conductive pencils and also with thin gloves)
- high resolution
- improved legibility and display brightness due to optimal light transmission
- Anti-glare-surface

In addition the technology of projective-capacitive touch screens is characterized by significant higher robustness and stability, because the active touch surface – different from common capacitive touch screens which were used until now - is located on the back side of the touch screen. Thus the active touch surface is not touched directly anymore and therefore will not wear off by normal use. As most of the surface contaminations do not cause an interference of the touch screen, this technology can be used in public or under severe environmental conditions.

Instructions for Using the Touch Screen

The touch screen responds to the lightest touches. The touch with only one finger is like the use of the left mouse button. The use of the touch screen with two fingers generates a zoom if the fingers are brought together or pulled apart. With a circular motion of the fingers the element on the display can be rotated. This function must be supported by either the operating system or by the application.

Cleaning Instructions

Always turn off the system before cleaning.



The glass surface of your Touch Screen should be cleaned with a mild, abrasive free, commercially available glass cleaning product. All pH neutral materials (pH 6 to 8) are good for cleaning. Cleaners with pH values 9 to 10 are not recommended. Cleaning with water and isopropyl alcohol is possible as well. Do not use solvents containing acetic acid. Use a soft, fine-meshed cloth to clean the surface. Dampen the cloth slightly and then clean the screen.



A wrong maintenance may cause damages to the screen, which are not covered by warranty.

Resistive Touch Screen

General Information

The resistive TFT Touch Screen is constructed by a hard-coated polyester top sheet that is overlaid on a conductively coated glass layer. Voltage is applied to the top sheet. As the user touches the screen, the top sheet compresses into contact with the glass layer, and current flows to the four corners in proportion to the distance from the edge. The controller then calculates the position of the finger or stylus, based on the current flow. Because the controller derives both the “X” and “Y” touch coordinates from the stable glass layer, the accuracy and operation of the touch screen is unaffected by damage to the top sheet caused by extended use or neglect.

Construction of the Resistive Touch Screen

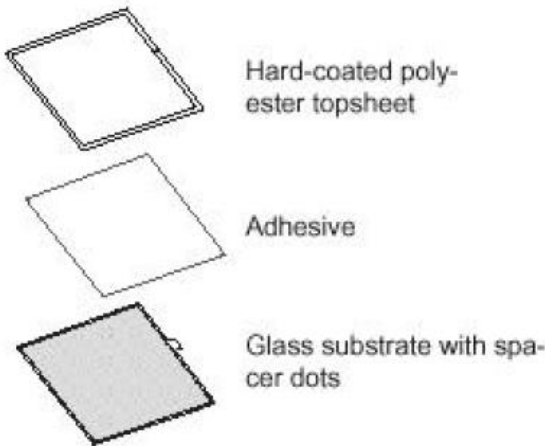

Instructions for Using the Touch Screen

Touching the touch screen has the same effect as clicking the left mouse button. You only need to apply a little pressure with the fingertip. In this resistive process not only fingertip contact is recognized. The screen does react in any way if touched, for example, with a stylus. The recommended material for a stylus is polyacetal. The stylus should have a minimum spherical radius of 0.8 mm and contain no sharp edges or burrs that may cause damage to the top sheet.

Cleaning Instructions

Always turn off the system before cleaning



The surface of your Touch Screen should be cleaned with a water-based solvent or a non-abrasive cleaner. Do not use solvents containing acetic acid or methylene chloride. Use a soft, fine-meshed cloth to clean the surface. Dampen the cloth slightly and then clean the screen.



A wrong maintenance may cause damages to the screen, which are not covered by warranty.

Planning the installation

This chapter provides you with the information you need to prepare for the installation of the system.

Dimensions

Please refer to the drawings below for dimensions of the desktop and wall mount versions. All dimensions are specified in millimetres. The views of the systems are not drawn to scale.

Desktop version

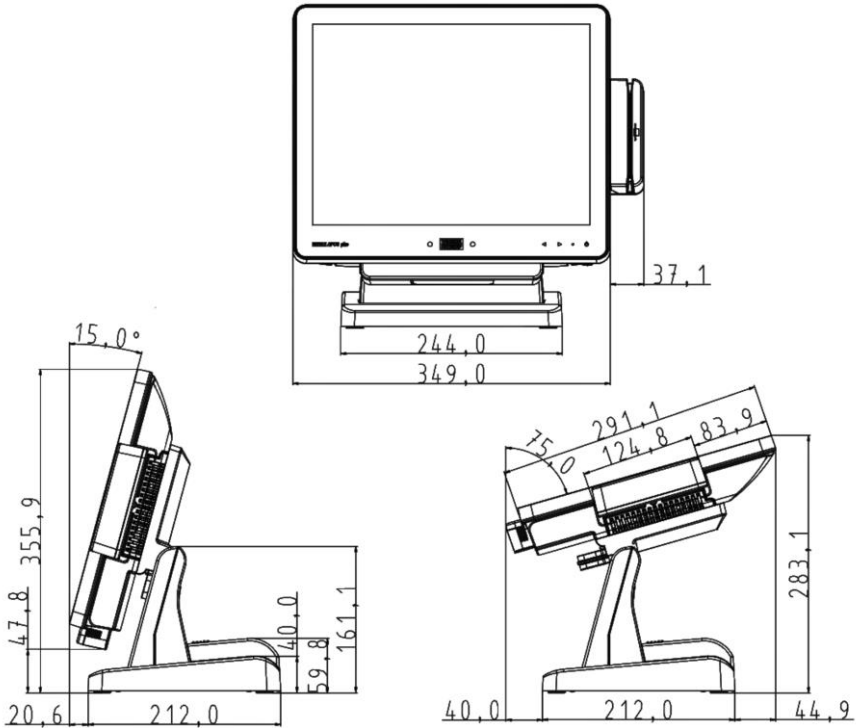

Wall mount version

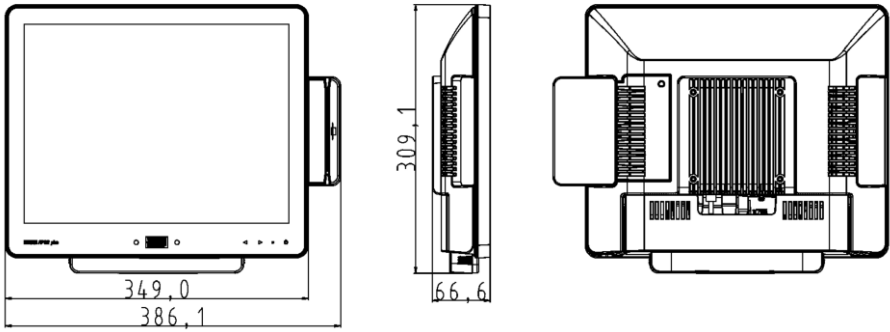

Required operation space

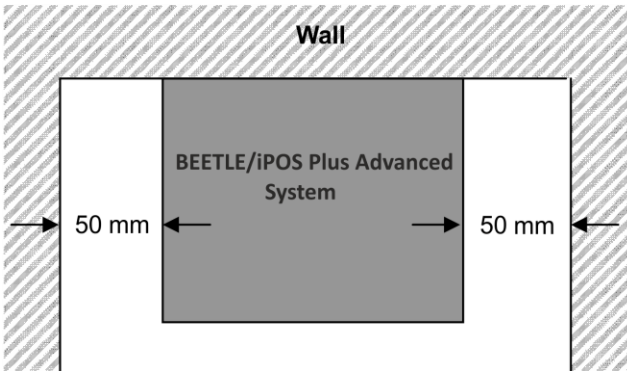

Maintain at least 50 from the side of the system to ensure proper ventilation during the operation of the system.

Installation site requirements

Desktop version

When selecting the installation site, ensure that:

- The area is flat leveled.
- The system to be installed on a table surface and not on a floor.

Wall mount version

- To reduce the risk that someone may accidentally walk into the system, location such as walkway areas, hallways areas or crowded areas are not recommended.
- Make sure that all applicable building and electric codes and accessibility requirements are followed.
- The mounting area must have adequate viewing area and ventilation, as well as access to an AC power outlet.
- The mounting method must be able to support the combined weight of the system and the suspended weight of all cables attached to the system.
- The system must be mounted to a solid concrete or brick wall with flat smooth surface.

Installing to a stand

Take the stand and the monitor out of the packaging. For installation you will need a Torx screwdriver to loosen and tighten the screws!

Preparing the stand

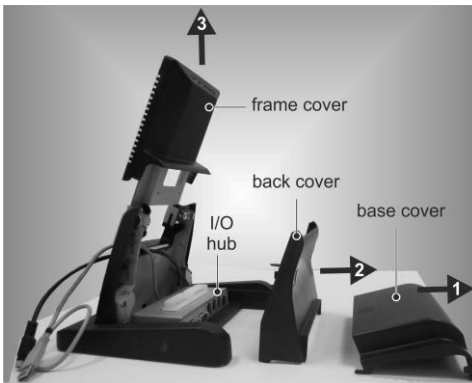

From the stand:

1. Remove the base cover.
2. Remove the back cover.
3. Remove the frame cover.

Preparing the display

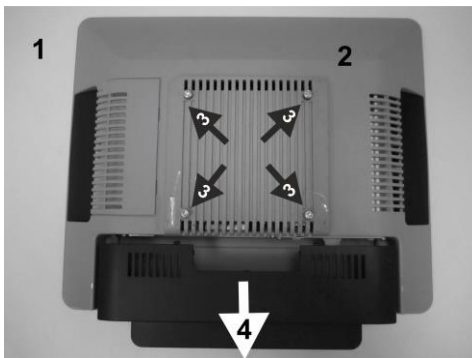

1. Place a piece of protection sheet on a flat surface e.g. a table.
2. Lay the display face down on the protection sheet.
3. Tighten the four screws half way through.
4. Remove the cable connection cover at the bottom of the display.

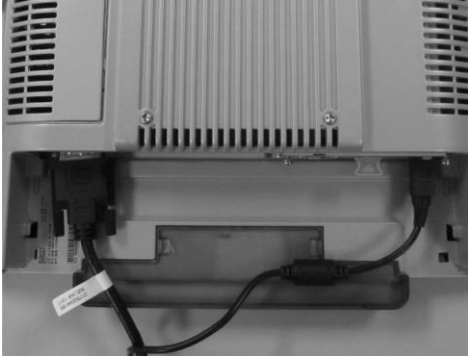

5. Plug in cables.



6. Pull the cable through the cable support.
7. Secure it with the cable clamps.



8. Place back the cable connection cover and pull the cables through the opening at the bottom.

Installing the stand

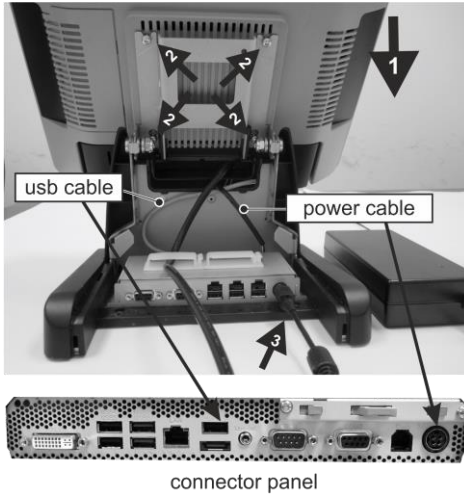

1. Bring the display to above the stand.
2. Locate the screws (that were previously tightened halfway through) to the four U-shaped groove on the frame of the stand.
3. Connect the power supply unit to the power socket at the I/O hub.
4. From the I/O hub, connect the power cable of to the power socket and the usb cable to the USB2 port on the connector panel.



5. Tighten the four Torx screws to secure the display to the stand.

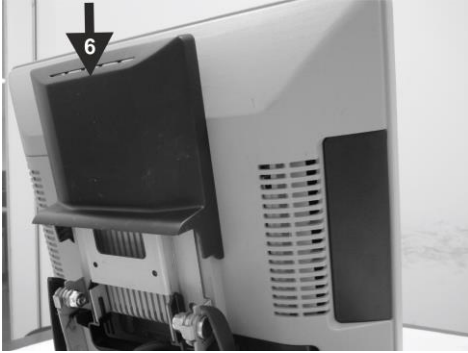

6. Place in the frame cover.



7. Place in the back cover, routing the cables through the bottom.



8. Place in the base cover. The installation is complete.

To uninstall, follow the steps in the reverse order.



When uninstalling the stand always make sure that all cables are disconnected.



Never connect data cables when the system is switched on.

Connector panel

The following sockets are located under the cable connection cover of the display:

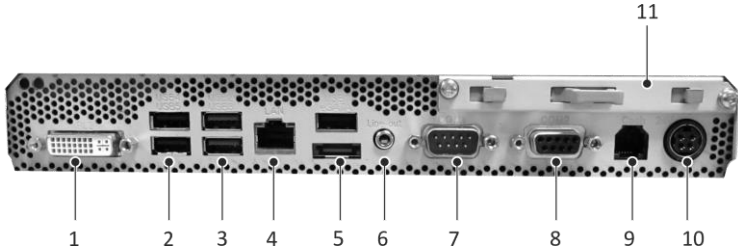

1	PLINK2
2	2 x USB 2.0 (USB Type A) (USB4 and USB5)
3	2 x USB 3.0 (USB2 and USB3)
4	LAN (RJ45)
5	1 x USB 2.0 (USB Type A) USB1 and eSATA
6	Line-out
7	Standard RS232C (COM1, DB9 male)
8	Powered RS232C (COM2, D89 female)
9	RJ12 (Cash drawer)
10	Connection to power (24V)
11	Mass storage (HDD/SSD)



Make sure that all additional devices have an **CE certificate**.

Connecting cables

All devices belonging to the modular BEETLE/iPOS plus Advanced that have a separate power cable must be connected to the same electric circuit.

Connect the system as described below.



1. Tilt the system to the back.



2. Pull down the cable connection cover to uncover the connector panel.





3. Connect cables to the assigned connectors.

Disconnecting cables

Never unplug a cable by pulling on the cable; always take direct hold of the plug itself. Follow the procedure below when disconnecting cables:

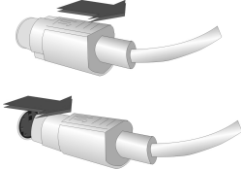
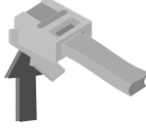
- Turn off all power and equipment switches.
- Remove the cable cover.
- Unplug all power plugs from the grounded-contact power sockets.
- Unplug all data communication cables from the sockets of the data networks.
- Unplug all cables from the devices.

	<p>With MINI-DIN plugs (Wincor Nixdorf keyboards), the plug remains inserted until released.</p> <p>Pull the plastic covering from the connecting socket with your thumb. The lock is released. The metal of the plug is visible.</p>
	<p>To release a RJ12 plug push the latch under the plug to the top.</p>
	<p>You loosen the USB-A- connector by pushing the <i>covering</i> of the connector.</p>

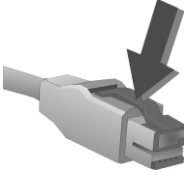
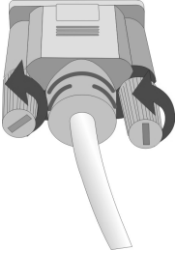
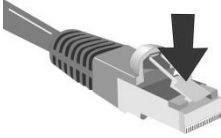
	<p>The P- USB connector is disengaged by pressing the spring that is marked by an arrow.</p>
	<p>Manually loosen the knurled screws of the COM or DVI interface connector.</p>
	<p>To release a RJ45 plug push down the latch (see arrow).</p>

Storage Media

Following storage media are available

- 1x 2.5" format-factor docking drive bay for 7mm thick hard disk or
- Solid State Disk (SSD)

A solid state disk drive is a data storage drive that uses memory elements in place of a rotating disk to store data. The SSD easily substitutes the hard disk and emulates a hard disk drive interface. The most SSDs are flash memory based.

Replacement of the Hard Disk Drive

First ensure that the device is **switched off** and that the power connector is disconnected.



1. Tilt the display to the back.



2. Pull down the cable connection cover to uncover the connector panel.

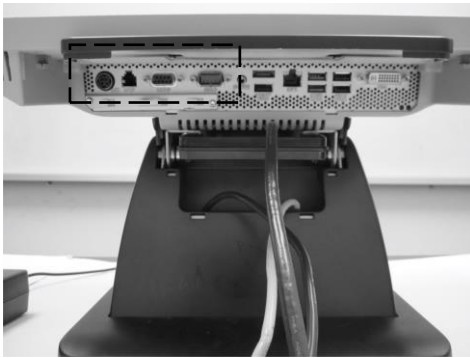

3. The HDD or SSD is in the drive carrier located on the left.



4. Remove both screws that fix the drive carrier to the connector panel and pull out the drive carrier.

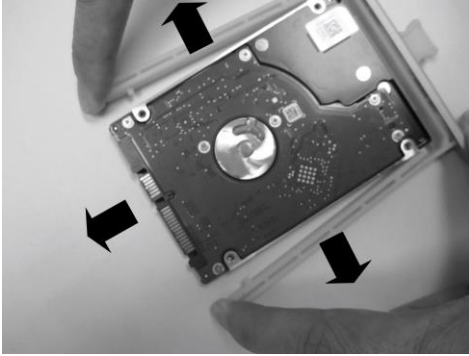

5. Release the catches on the drive carrier and pull out the hard disk.

Handle the hard disk with care while removing or installing it. Do not touch the exposed electronics.



6. Replace the new hard disk and fix it back to the drive carrier.

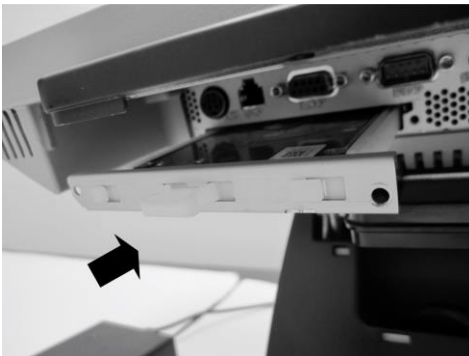

7. Insert the disk carrier into the connector panel.

Fix it with the two screws, removed previously.

The replacement is complete.

Second Hard Disk Drive

There is an option to install a second hard disk in certain versions of BEE-TLE /iPOS plus Advanced. This is available in a kit. Please contact your local representatives for details.

Installing the second hard disk drive

Unpack the parts and check whether the delivery matches the details of the delivery note.

The kit contains the following parts.

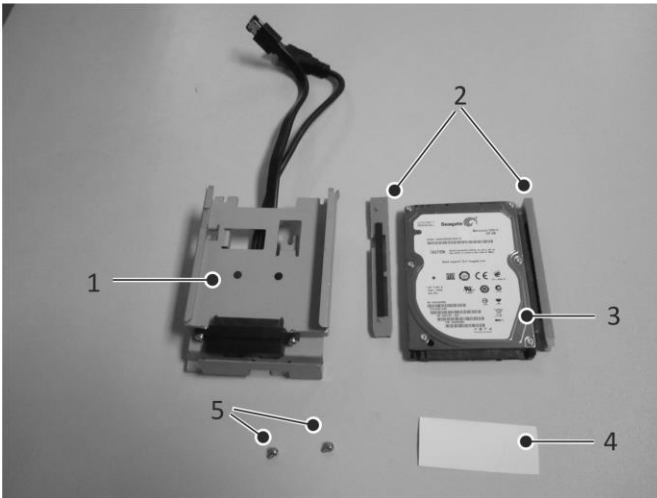

1	HDD bracket with docking cables
2	Guide rails
3	Hard disk drive
4	Protective layer
5	Screws

First ensure that the device is **switched off** and that the power connector is disconnected.



1. Remove the covers of the stand.



To prevent injury during installation, stick the protective layer provided over the edge of the frame as shown (1).

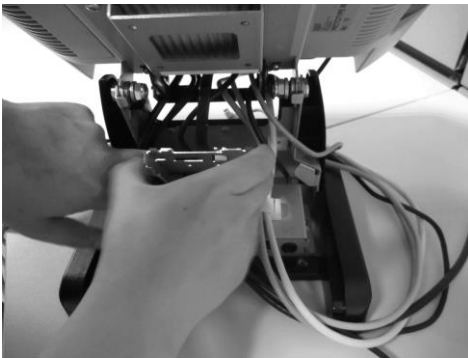

2. Locate the HDD bracket over the assigned connector for the second hard disk drive. Ensure the bracket fit in properly.

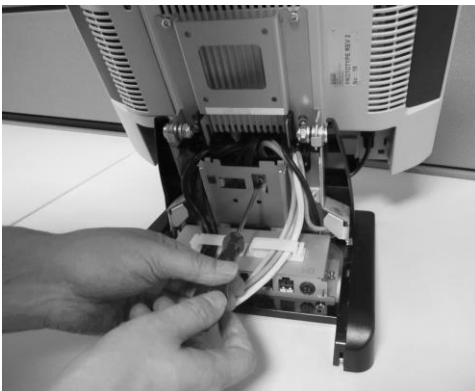

3. Secure the bracket with the screws provided.



4. Assemble the guide rails to the hard disk drive.



5. Slide the hard disk drive assembly into the HDD bracket.



6. Apply a slight pressure to ensure that the hard disk drive assembly is engaged with the docking cables.

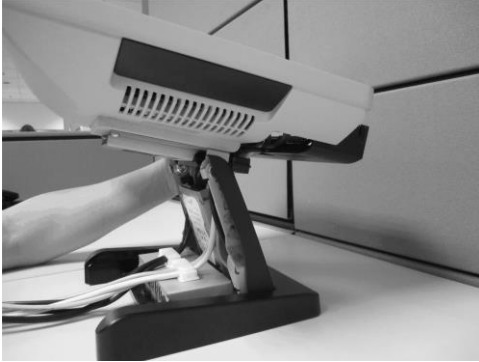

7. Tilt the display to the back.

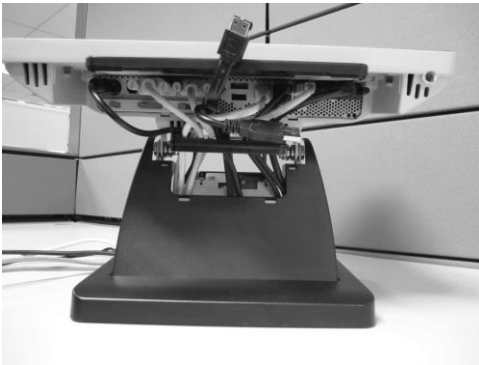

8. Pull the cables to the connector panel below the display .



9. Connect the cables to the USB1 and eSATA connectors.

The installation is complete.

To uninstall, follow the steps in the reverse order.

Replacement of the RAM

First ensure that the device is **switched off** and that the power connector is disconnected.



1. Remove the flap using a screw driver.

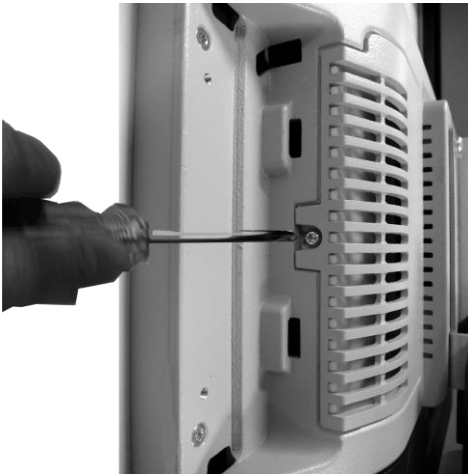

2. Remove the screw the fix the RAM cover to the system.

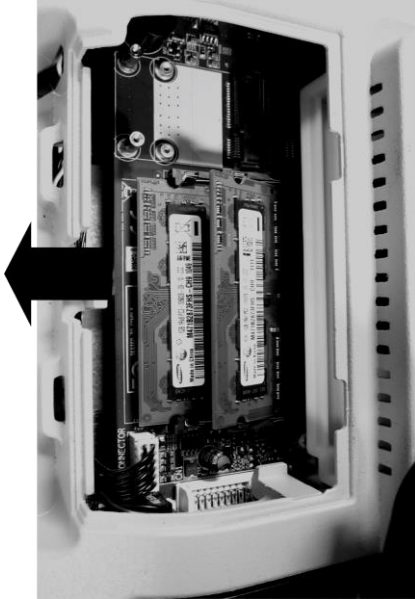

3. Release the catches of the RAM holder and pull out the RAM.
4. Replace the new RAM and fix it back to the holder.
5. Repeat steps 1 and 2 in the reverse order.

The replacement is complete.

Installing to a wall

Unpack the parts from the wall mount kit and check whether the delivery matches the details of the delivery note.

Things you need

The kit contains:

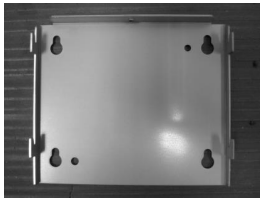

Wall mount back plate
Quantity: 1 piece



Wall mount front plate
Quantity: 1 piece

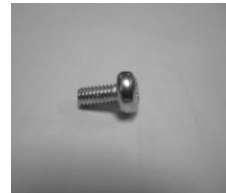

M4x8 Torx screws
Quantity: 4 pieces

For installation you will need the following (not supplied):

- a drill set
- a Torx screwdriver
- a marker
- 4 pieces of fasteners*

*Fastener types

Fasteners are not included in the wall mount kit. The recommended fastener types to wall mount the system are:

Fischer universal plug (UX 6 x 50) (<http://www.fischer.de>)

Recommended Screw for wall is Pan head self-tapping M5 x 55.

Drill Diameter: 6 mm

Min Hole Depth: 60 mm

Load per anchor for concrete: 60 kg (Safety factor accounted for)

Load per anchor for Solid brick: 30 kg (Safety factor accounted for)

Thorsman wall plug (TP 6 x 30) (<http://www.thorsman.com>)

Recommended Screw for wall is Pan head Wood Screw TGS-C3- 4.8 x 38L

Drill Diameter: 6 mm

Min Hole Depth: 40 mm

Load per anchor for concrete: 40 kg

Load per anchor for Solid brick: 30 kg

Safety factor: 6



Preparation

Connecting the display

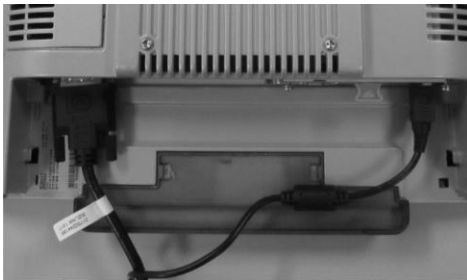
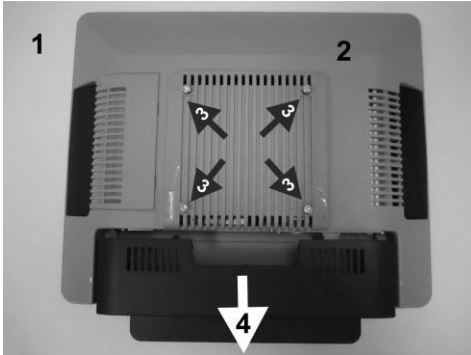

1. Place a piece of protection sheet on a flat surface e.g. a table.
2. Lay the display face down on the protection sheet.
3. Remove the four screws from the back of the display.
4. Remove the cable connection cover at the bottom of the display.
5. Plug in cables.
6. Place back the cable connection cover and pull the cables through the opening at the bottom.

Mounting height

The mounting height of the system should be appropriate and comfortable for the majority of users.

Based on the recommendation of the ADA (American Disability Association), it is recommended that the highest point of the display should not exceed 1370mm height.

It is also recommended that the system is approximately 122cm (48 in) from the floor to the centre of the display when the user is in the standing position.

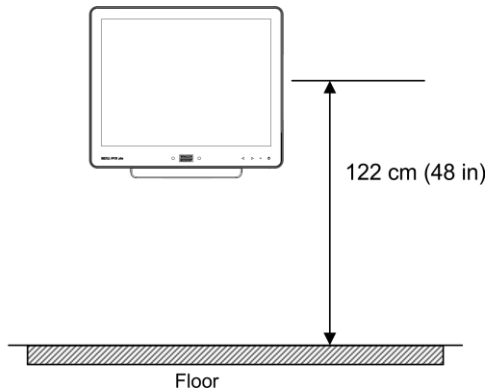

Mounting location

Once you have determine the mounting height, with the help of the wall mount back plate, mark the location of the four holes on the wall.

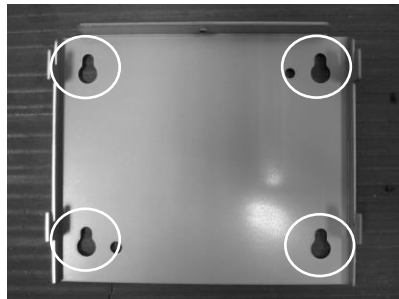

Installation



The wall mount plate must be installed by a professional and qualified installer who is familiar with the building construction methods and the electrical code that are govern by the local laws on the public access areas.

Use only Wincor Nixdorf wall mount plate.

Fix wall mount back plate to the wall

- Prepare the mounting points penetrating from the wall according to the dimension of the mounting holes on the back of the system.
- When the system is mounted onto the wall, ensure that the wall mount back plate must be attached permanently and securely to prevent the system from falling and damaged. Failing to do so may also cause injury to others.
- Use the recommended fasteners (not supplied) to attach the wall mount back plate onto the concrete wall.
- Check and ensure that the wall mount back plate is mounted squarely by using a bubble level.
- After installation, ensure that the screw heads are flushed or below the outer surface of the wall mount back plate.
- Ensure that the wall mount back plate is firmly and securely attached to the wall.

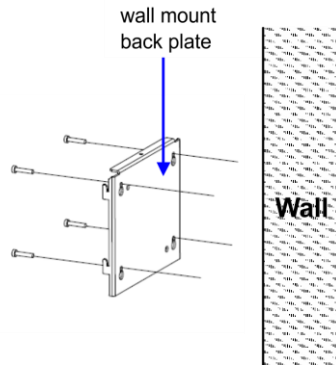

Fix wall mount front plate to the system

- Align the 4 mounting holes of the wall mount front plate onto the mounting holes at the back of the display.

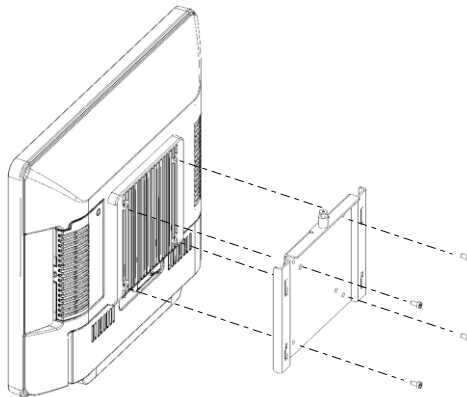

- Secure the wall mount front plate onto the display using the screws provided in the wall mount kit.

Secure the system to the wall

- Ensure that the power cable has been connected onto the system.
- Hook the system with its wall mount front plate installed, onto the wall mount back plate that has been mounted on the wall. Ensure that

the hooks at both sides of the wall mount back plate are securely locked on the slots of the wall mount front plate.

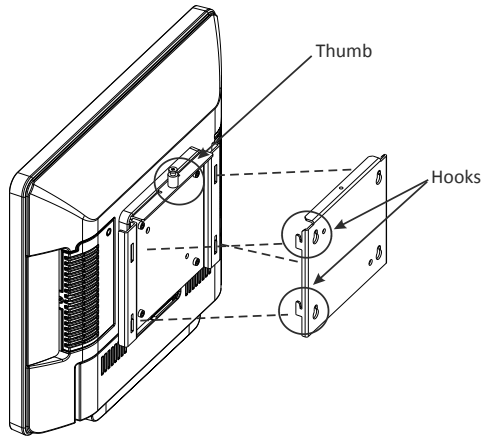

- Tighten the thumb screw on the top of the wall mount front plate to secure the hooks of the wall mount plates.
- Dress the cables routing according to the store set up or the overall installation site plan

Peripherals

Magnetic Swipe Card Reader (Option)



There are two types of MSR module to choose from, the standard ISO 3-track or the dual-head JIS1/JIS2. Card reading is bi-directional.

The MSR module can be mounted either on the right or left side of the display.

How To Operate

Run the swipe card through the slit of the swipe card reader from top to bottom in a quick and steady movement. Make sure that the magnetic strip is to the right. When using swipe cards, the following should be observed:

- Swipe cards should never be allowed to come into contact with liquids.
- Swipe cards should not be bent or folded in any way.
- Swipe cards should not be allowed to come into close contact with a magnetic field.

Swipe cards should only be inserted in the top of the specially designed slit of the reading device. If the card is inserted in another place, this could damage the reading head.

Cleaning Instructions

In order to guarantee good reading results, the swipe card reader should be cleaned from time to time. This is carried out by using a special cleaning card that can be purchased from Wincor Nixdorf.

Waiter Lock (Option)



Each transaction is correctly assigned to the personnel by using the magnetic key. The magnetic keys are available in 10 different colors. The magnet keys are waterproof, shatterproof and by the 16-digit key number also safe for clear identification.

The operation of the system is very simple, the key is placed onto the magnetic probe (see figure). The key is held magnetically to the probe and transmits the data by an electrical USB interface.

The readout of the data may be integrated easily in a software application.



For guide on software application programming, please refer to BA9x MSR/Waiter Lock Programming Manual.

Installing peripherals

Unpack the parts and check whether the delivery matches the details of the delivery note.

The kit contains the Magnetic Swipe Card Reader (MSR) with holder or the Waiter Lock with holder and two screws.



Magnetic Swipe Card Reader kit



Waiter Lock kit

The Magnetic Swipe Card Reader and Waiter Lock can be installed on either the right or the left side of the screen. You will find a flap at the rear side of the system at the position for the peripherals.



1. Remove the flap using a screw driver, exposing one end of a connecting cable.



2. Release the catch on one side of the peripheral's holder.

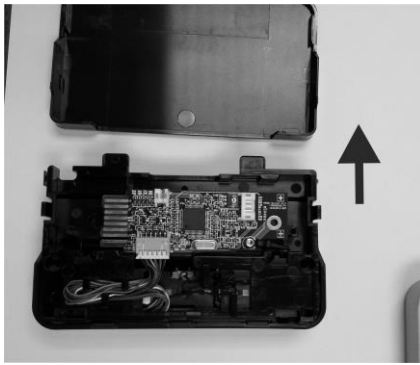

3. Remove the back cover of the holder.

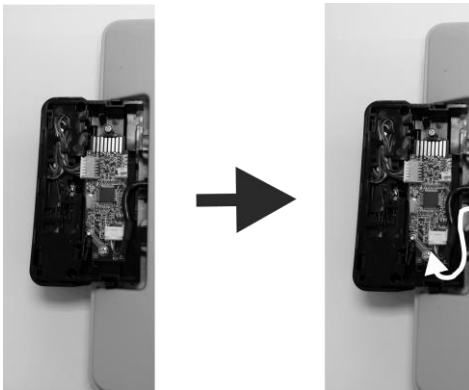

4. Locate the holder to the side of the display uncovered in step 1.

Route the connecting cable mentioned in step 1, into the holder and connect to the connector.



5. Use the two screws supplied to secure the holder to the display.

Place in the back cover of the peripheral. The mounting is complete.

Starting Up the System

After installing the BEETLE /iPOS plus Advanced, switch on the system by using the Power button on the front panel.

The system first performs an automatic self-test to test its basic functions. For example, you may see the following message (irrespective of processor type) on the monitor:

```
WN „ID xx/xx Date“
```

xx/xx is the *placeholder* of the BIOS version number.

The system then determines the medium from which the operating system and the application are to be booted. Each medium is assigned a logical drive according to the configuration of your BEETLE /iPOS plus Advanced.

The following media can be assigned a drive:

- Network
- Hard disk drive/solid state drive
- USB drive

The logical drives are designated C: and D:.

The network is always assigned to the C: drive during the runup procedure. The hard disk can be assigned to the C: or D: drive. The system can only be started from the hard disk if the disk has been configured as the C: drive.

Corresponding to the Setup configuration the modular BEETLE /iPOS plus Advanced can be booted from the following drives:

- Hard disk drive C:
- LAN module with BOOTPROM
- USB drive

Please mind that the storage medium must be *system-boot-capable*. If the operating system started up without an error, the application software is automatically booted, if necessary.

A message is displayed as soon as the BEETLE /iPOS plus Advanced is ready for operation. For more detailed information see the manual for your application program.

Error reporting

When an error condition is detected, it is reported by a repetitive train of blinking red LED. Decode by counting the number of blinks in a train and check against the error code table below.

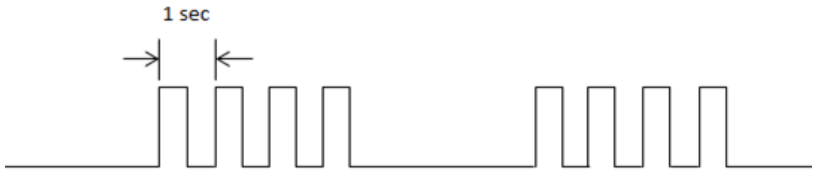

Number of pulses	Error description
1	Hard Disk 1 failed (internal hard disk)
2	Hard Disk 2 failed (external hard disk)
3	
4	Processor fan is faulty
5	Capacitive Sense board is faulty
6	

Technical Data

		Wall mount	Desktop
Dimensions	Diagonal Screen size	15" (38.1 cm)	
	Active screen size (mm) (horizontal x vertical)	304.1 x 228.1	
	Display housing dimensions	Refer to chapter "Planning the installation"	
Weight		4 kg	7 kg
Climatic class		DIN IEC 721-3-3 Class 3K3 up to 40°C	
Operating temperature		+5°C to +40°C	
Humidity		5% to 85% Absolute humidity 1g/m ³ to 25g/m ³ Condensation is not permitted	
Frequencies	Horizontal (KHz)	typ. 48.3	
	Vertical (Hz)	typ. 60	
Resolution	Horizontal (Pixel)	1024	
	Vertical (Pixel)	768	
	Colour depth	Up to 16.7 Mio.	
Pixel format (Approx. in mm]		0.30 x 0.30	
Interface	internal	mSATA, mPCIe, SATA III	
	external	PLINK2, USB, cash drawer, RJ45, eSATA, RS232C	
Reading Angle, right/left top/ bottom		+/- 80 ° +/- 80 °	
Brightness	Projected Capacitive	250 cd/m ²	
	Resistive	220 cd/m ²	
Backlight		LED	

AC Power Adapter

Only use power supply units (PSU) released or approved by Wincor Nixdorf
The PSU has to comply with the following minimal requirements and common standards:

Rated input voltage	100-240VAC
Rated input current	2.0A
Input frequency range	47-63 Hz
Rated output voltage	24V \pm 5%
Rated output current	5.0A
Max. output power	120W at ambient of 45 degree C, 100W at ambient of 55 degree C
Approvals and Certification	UL Listed, TÜV-GS, CE

Projected Capacitive Touch Screen

Resolutions	Horizontal	2048
	Vertical	2048
Touch technology		Projected Capacitive
Surface		Anti-glare
Data transfer		USB
Multi Touch		2-points (Gestures Supported)

Resistive Touch Screen

Resolutions	Horizontal	2048
	Vertical	2048
Touch technology		5 wire Analog Resistive
Surface		Anti-glare
Data transfer		USB

MSR Module

Power supply	USB BUS powered
Connection	USB 2.0
Protocol	HID 1.1 (Human Interface Device)
Number of tracks	Up to 3
Coding of swipe card reader	According ISO 7811-2 or JIS B 9561
Reading speed	10 to 140 cm/sec.
Height	179 mm
Width (Screen mounted)	51 mm
Depth	40 mm
Weight	Approx. 138 g

Waiter Lock (iButton) Module

Power supply	USB BUS powered
Connection	USB 2.0
Protocol	HID 1.1 (Human Interface Device)
Device supported	Olitronic GmbH magnetic key, 99-L-01 (DS1990A)
Physical Interface	1-Wire, serial
Height	179 mm
Width (Screen mounted)	51 mm
Depth	40 mm
Weight	Approx. 107 g

iPOS plus I/O Hub

Power input	DC24V IN	24V DC (connect to 24V power supply)
User interface	COM5	Rated voltage: 12V, 5V
	COM6	Rated current: 1A combined (each supply)
	PSUB12V	2x powered USB, rated 3A
	PSUB24V	1x powered USB, rated 3A
Power output	DC24 V Out	24V DC (connect to iPOS plus Advanced)
USB Upstream		USB Type B (connect to eSATA port of iPOS plus Advanced)
2 nd HDD Power		For optional second hard disk

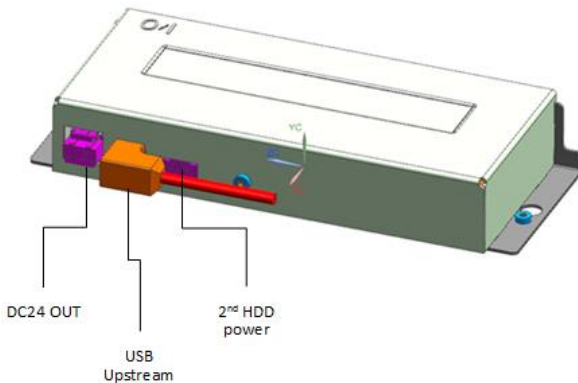
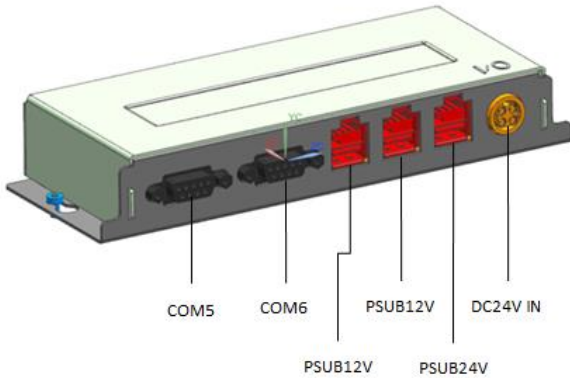

Appendix

Approved Printers List

The following are the approved printers that are allowed to be connected to the BEETLE /iPOS plus Advanced's +24Vdc Powered USB port:

	Model	Manufacturer
1	TH180 series	Wincor Nixdorf
2	TH230 series	Wincor Nixdorf
3	TH320 series	Wincor Nixdorf
4	TH420 series	Wincor Nixdorf
5	ND210 series	Wincor Nixdorf
6	ND77 series	Wincor Nixdorf
7	TH200 series	Wincor Nixdorf



Connecting printer that are not in the above approved list to the **+24Vdc Powered USB port** may cause safety hazard and endanger the user and the nearby people. Please consult Wincor Nixdorf if in doubt.

Abbreviations

CE	European Symbol of Conformity
CFC	Chlorofluorocarbon
CHC	Chlorinated hydrocarbon
COMn*	Powered RS 232 Interface (Asterisk denotes Power)
cUL	Canadian Registration (Recognized by UL)
DIN	Deutsches Institut für Normen (German Institute for Standards)
D-Sub	D- Shaped Sub miniature
ESD	Electronically Sensitive Devices
HDD	Hard Disk Drive
IEC	International Electrotechnical Commission
ISO	International Organization for Standardization,
LAN	Local Area Network
LED	Light Emitting Diode
PEN	Protective Earth Neutral Conductor
RAM	Random Access Memory
SSD	Solid State Disk (flash medium)
TN-S	Terre Neutre- Separé
UL	Underwriters Laboratory (standards)
USB	Universal Serial Bus
VGA	Video Graphics Adapter
VESA	Video Electronics Standards Association
WN	Wincor Nixdorf International GmbH

Wincor Nixdorf Pte Ltd
151 Lorong Chuan
New Tech Park
#05-01A/B
Singapore 556741

Order No.: **01750259126C**